

# linea xs mp



tunableWhite





TECHNISCHES DATENBLATT

# linea xs mp

## tunableWhite

### Technische Daten

Abmessungen	46 mm x 57 mm [B x H] 1.80 in x 2.25 in [B x H]
Leuchtenlängen	324 mm, 477 mm, 629 mm, 782 mm, 934 mm, 1087 mm, 1239 mm 12.76 in, 18.78 in, 24.77 in, 30.79 in, 36.78 in, 42.80 in, 48.78 in
Leuchtentyp	 tunableWhite
Farbtemperaturen tunableWhite	2200 K - 4000 K * Projektbezogene Farbtemperaturbereiche für tunablewhite möglich
Abstrahlwinkel	8°, 10°, 23°, 43°, 8° x 31° 10° x 42°, 12° x 60°, 14° x 100°, 30° x 60°, 60° x 30°
Lichtquelle	324 mm (12.76 in): 8 LEDs 477 mm (18.78 in): 12 LEDs 629 mm (24.77 in): 16 LEDs 782 mm (30.79 in): 20 LEDs 934 mm (36.78 in): 24 LEDs 1087 mm (42.8 in): 28 LEDs 1239 mm (48.78 in): 32 LEDs
Entblendung	optional: <ul style="list-style-type: none"><li>internes Wabenraster</li><li>internes lineares Entblenderaster</li></ul>
LED-Binning	
MacAdam-Ellipsen Binning	3
Steuerung	DALI, DMX

Eingangsspannung	Netzteil: extern   36 VDC		
Wirkleistungsaufnahme	324 mm (12.76 in):	Max. 10 W	
	477 mm (18.78 in):	Max. 15 W	
	629 mm (24.77 in):	Max. 20 W	
	782 mm (30.79 in):	Max. 25 W	
	934 mm (36.78 in):	Max. 30 W	
	1087 mm (42.8 in):	Max. 35 W	
	1239 mm (48.78 in):	Max. 40 W	
Schutzklasse	II		
Lagertemperatur	-40 °C / +80 °C   -40 °F / +176 °F		
Betriebstemperatur	-40 °C / +40 °C   -40 °F / +104 °F		
Einschalttemperatur	-25 °C / +40 °C   -13 °F / +104 °F		
Lebensdauer [L70]	65'000 h @ 25 °C (77 °F)   40'000 h @ 40 °C (104 °F)		
Gehäuse	Aluminium-Strangpressprofil		
Gehäusefarbe(n)			
	Aluminium natur eloxiert (Standard)	Schwarz eloxiert	
Linse	Gehärtetes Sicherheitsglas, extra weiß		
Gewicht	324 mm (12.76 in):	1,5 kg (3.31 lbs)	
	629 mm (24.77 in):	2,1 kg (4.63 lbs)	
	934 mm (36.78 in):	3,2 kg (7.05 lbs)	
	1239 mm (48.78 in):	4,4 kg (9.70 lbs)	
Schutzart	IP66		
Umgebung			
	indoor	outdoor	
Schlagschutz	IK08		
Zulassungen			

# Abstrahlwinkel

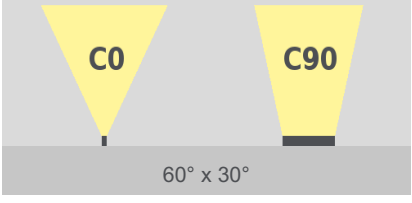
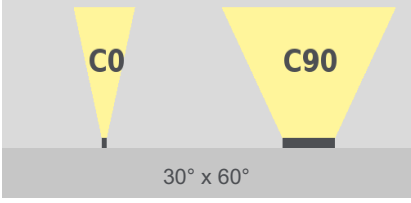
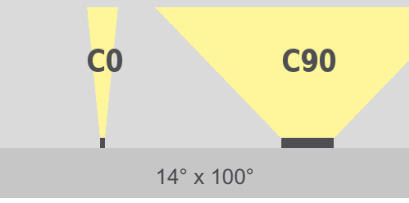
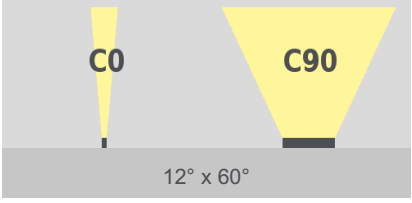
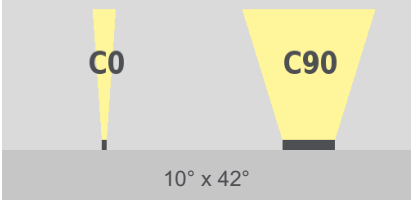
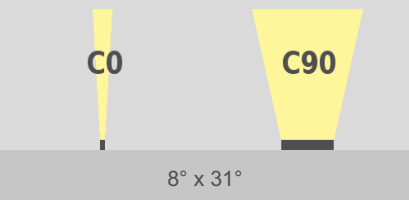
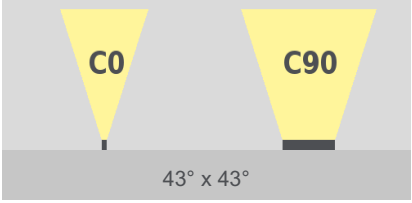
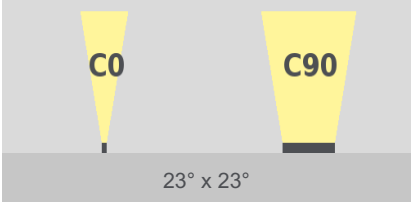
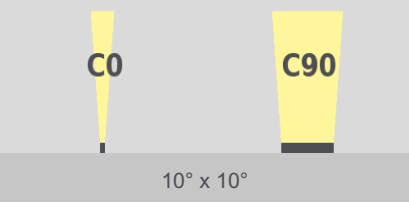
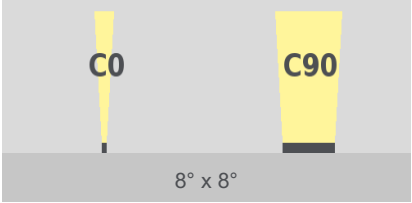

# Technische Zeichnung

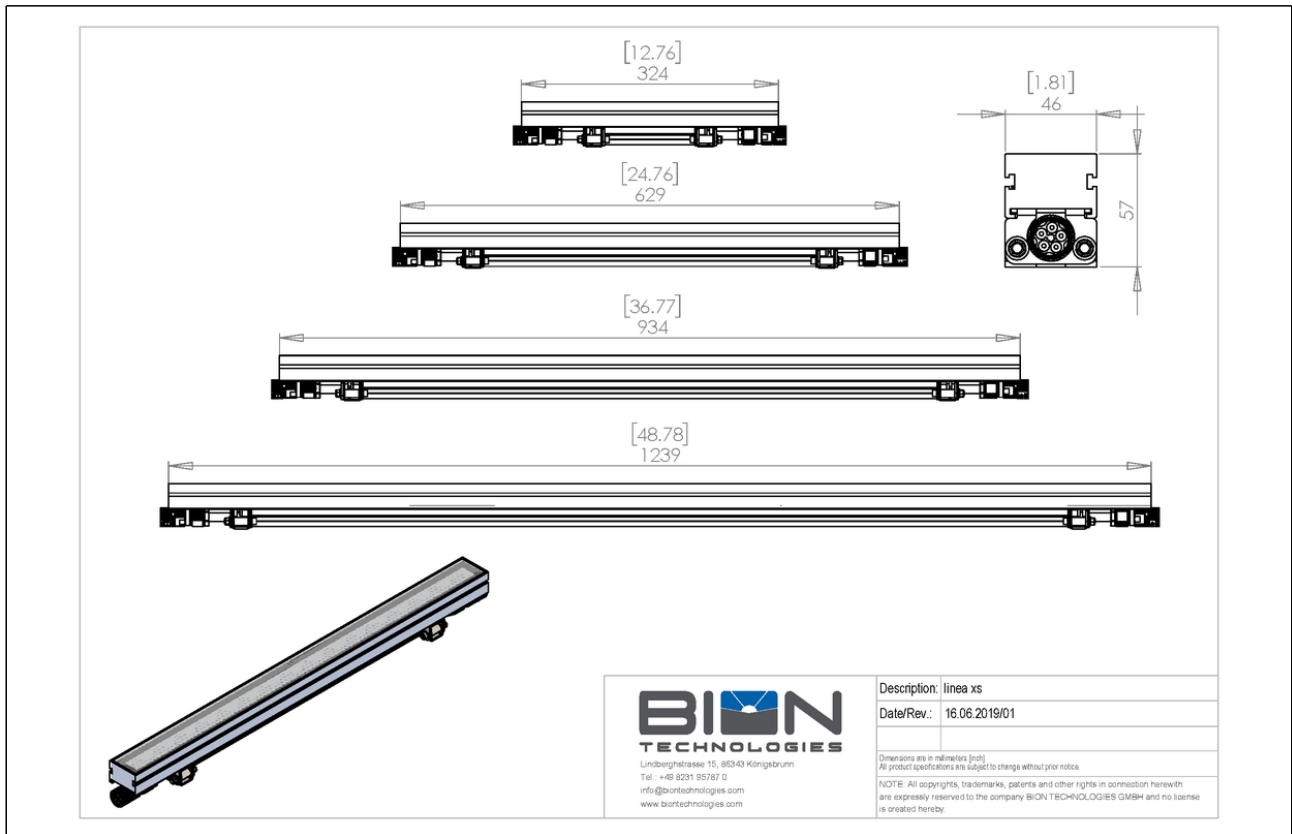

Projekt	Leuchten#	Datum
		Firma



## Bestellinformationen

Wählen Sie Ihre Wunschkonfiguration aus und schreiben Sie dann die Kodierung in das entsprechende Feld, um somit die Produktnummer zu erstellen.

LIN-XS-MP- TW2240 - DIMMUNG - LEUCHTENLÄNGE - ABSTRAHLUNG - GEHÄUSEFARBE - ENTBLENDUNG - VERDRAHTUNGS KONFIGURATION - ANSCHLUSSLEITUNGSLÄNGE - BEFESTIGUNGSOPTION - Y01

TYP - LICHTFARBE		DIMMUNG		LEUCHTENLÄNGE		ABSTRAHLUNG		ENTBLENDUNG		VERDRAHTUNGS KONFIGURATION		ANSCHLUSSLEITUNGSLÄNGE		BEFESTIGUNGSOPTION	
<b>TYP - LICHTFARBE</b> TW2240 tunableWhite - 2200 K - 4000 K		<b>DIMMUNG</b> DALI Dimmbar - DALI DMX Dimmbar - DMX		<b>LEUCHTENLÄNGE</b> 324 324 mm / 12.76 in 477 477 mm / 18.78 in 629 629 mm / 24.76 in 782 782 mm / 30.79 in 934 934 mm / 36.77 in 1087 1087 mm / 42.8 in 1239 1239 mm / 48.78 in		<b>ABSTRAHLUNG</b> 8X8 8° x 8° 10X10 10° x 10° 23X23 23° x 23° 43X43 43° x 43° 8X31 8° x 31° 10X42 10° x 42° 12X60 12° x 60° 14X100 14° x 100° 30X60 30° x 60° 60X30 60° x 30°		<b>ENTBLENDUNG</b> OP Keine Entblendung HL internes Wabenraster LLO internes lineares Entblenderaster		<b>VERDRAHTUNGS KONFIGURATION</b> IOCC IN/OUT mit Steckverbindung IXCX nur IN mit Steckverbindung IOOC IN offenes Ende / OUT Buchse IOOO IN/OUT mit offenen Enden IXOX nur IN mit offenen Enden		<b>ANSCHLUSSLEITUNGSLÄNGE</b> ETE Ende zu Ende- Verkabelung 003 + 30 cm (ca. 1 ft) 006 + 60 cm (ca. 2 ft) 009 + 90 cm (ca. 3 ft) 012 + 1,2 m (ca. 4 ft)		<b>BEFESTIGUNGSOPTION</b> ND ohne Halter BS Universalhalterung	
		<b>GEHÄUSEFARBE</b> AA Aluminium natur eloxiert (Standard) BA Schwarz eloxiert													

\* Projektbezogene Optionen sind verfügbar - Bitte kontaktieren Sie Ihren Ansprechpartner für weitere Informationen.



Lindberghstrasse 15  
86343 Koenigsbrunn  
Tel: +49 (0)8231/95787-0  
Fax: +49 (0)8231/95787-29  
[www.biontechnologies.com](http://www.biontechnologies.com)  
[info@biontechnologies.com](mailto:info@biontechnologies.com)

YouTube: <http://www.youtube.com/user/BIONTECHNOLOGIES>

© 2024, BION TECHNOLOGIS GMBH  
All rights reserved / Subject to change / Specifications may change without notice