



tantulus hp outdoor



tunableWhite





TECHNICAL DATASHEET

tantulus hp outdoor

tunableWhite

Technical Data

Dimensions	22 mm x 36 mm [W x H] with bracket / hinge 0.87 in x 1.42 in [W x H] with bracket / hinge
Standard Unit Lengths	310 mm, 615 mm, 920 mm, 1225 mm, 1530 mm, 1835 mm 12.21 in, 24.22 in, 36.23 in, 48.23 in, 60.24 in, 72.25 in
Fixture Typ	 tunableWhite
Color Temperatures tunableWhite	2600 K - 4400 K * Project-specific color temperature ranges for tunableWhite available.
Beam Angles	30° x 120°, 120°, 120°, 160°
Luminous Flux	310 mm (12.21 in): 250 lm 615 mm (24.22 in): 500 lm 920 mm (36.23 in): 750 lm 1225 mm (48.23 in): 1000 lm 1530 mm (60.24 in): 1250 lm 1835 mm (72.25 in): 1500 lm
Light Source	310 mm (12.21 in): 20 LEDs 615 mm (24.22 in): 40 LEDs 920 mm (36.23 in): 60 LEDs 1225 mm (48.23 in): 80 LEDs 1530 mm (60.24 in): 100 LEDs 1835 mm (72.25 in): 120 LEDs
R9	20
LED-Binning	
MacAdam Ellipses Binning	2

Input Voltage	Power supply: external 36 VDC	
Power Consumption	310 mm (12.21 in):	Max. 5 W
	615 mm (24.22 in):	Max. 10 W
	920 mm (36.23 in):	Max. 15 W
	1225 mm (48.23 in):	Max. 20 W
	1530 mm (60.24 in):	Max. 25 W
	1835 mm (72.25 in):	Max. 30 W
Protection Class	II	
Storage Temperatur	-20 °C / +40 °C -4 °F / +104 °F	
Operating Temperature	-20 °C / +40 °C -4 °F / +104 °F	
Start-up Temperature	-20 °C / +40 °C -4 °F / +104 °F	
Lumen Maintenance [L70]	40'000 h @ 25 °C (77 °F) 25'000 h @ 50 °C (122 °F)	
LED-Class	Class 2 LED Product	
Housing	Aluminium	
Housing Color(s)	 Aluminium anodized (Standard)	
Lens	Material: PMMA	
	Translucency	
	frost	89%
	white	70%
Ingress Protection	IP65	
Environment	 indoor  outdoor	
Certification		

Beam Angles

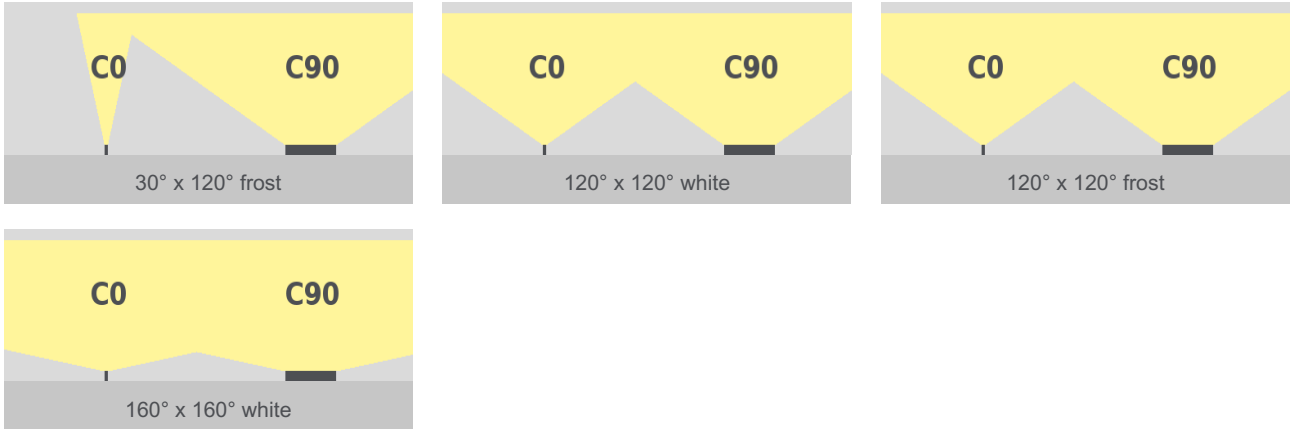

Engineering Drawing

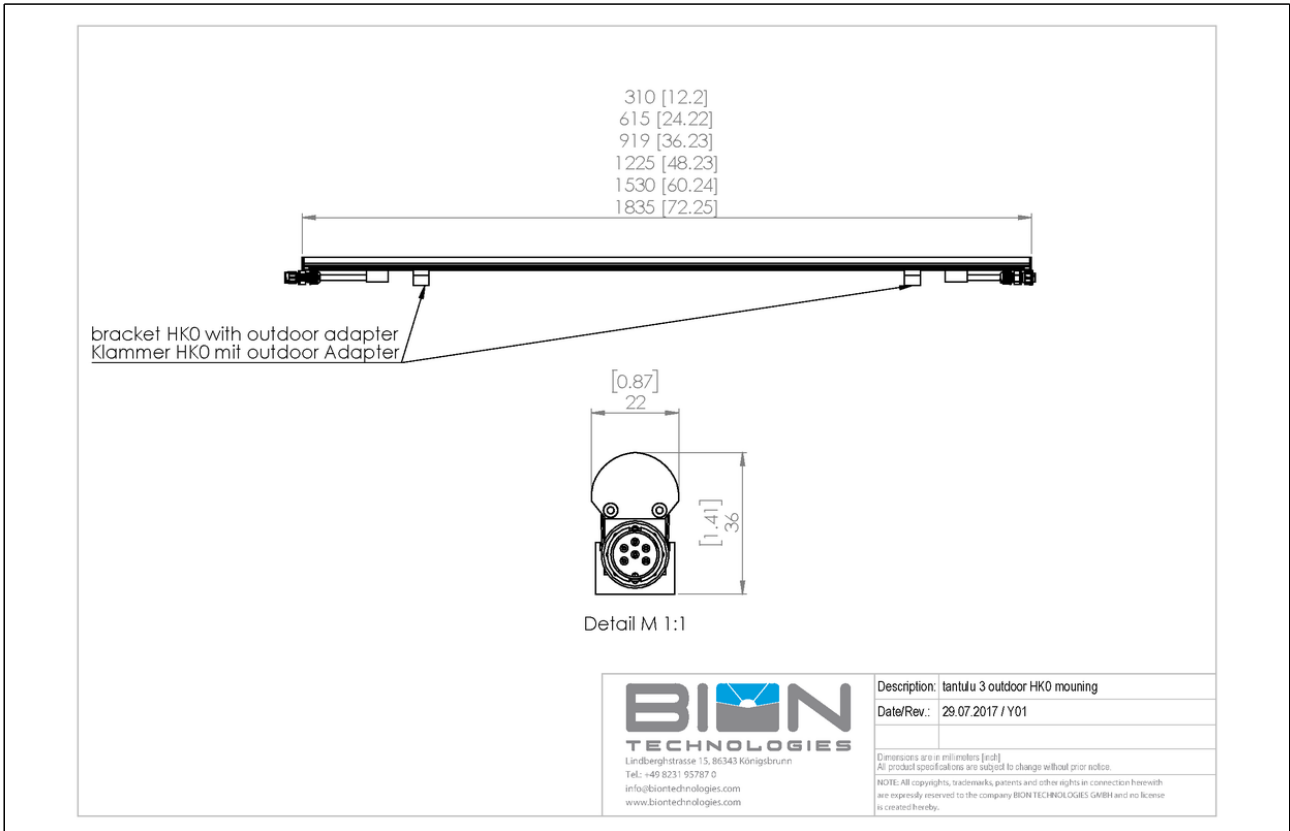

Project	Fixture#	Date
		Firm

Ordering Information

Choose the option that suits your needs and write its corresponding code on the appropriate line to form the product code.

TAN-OUT-HP-- TW2644 - _____ - _____ - Y31

TYP - LUMINOUS COLOR FIXTURE LENGTH BEAM ANGLE MOUNTING OPTION

TYP - LUMINOUS COLOR	
TW2644	tunableWhite - 2600 K - 4400 K

FIXTURE LENGTH	
310	310 mm / 12.2 in
615	615 mm / 24.21 in
920	920 mm / 36.22 in
1225	1225 mm / 48.23 in
1530	1530 mm / 60.24 in
1835	1835 mm / 72.24 in

MOUNTING OPTION	
K0	Bracket Set 0°
K15	Bracket Set 15°
K30	Bracket Set 30°
K45	Bracket Set 45°
K60	Bracket Set 60°
KADJ	Positioning Hinge
Fixed Angle: Bracket count: 2 <= 1225 mm (48.23 in) > 3 HKadj: Bracket count: 2 for all lengths	

BEAM ANGLE	
30X120F	30° x 120° frost
120X120W	120° x 120° white
120X120F	120° x 120° frost
SQR(W)	160° x 160° white

* Project-specific options are available - Please contact our Sales Representative for further information.



Lindberghstrasse 15
86343 Koenigsbrunn
Tel: +49 (0)8231/95787-0
Fax: +49 (0)8231/95787-29
www.biontechnologies.com
info@biontechnologies.com

YouTube: <http://www.youtube.com/user/BIONTECHNOLOGIES>

© 2021, BION TECHNOLOGIS GMBH
All rights reserved / Subject to change / Specifications may change without notice